

CG2-2000 2V 2000Ah(10hr)

Gel battery shows some distinctive advantages over flooded battery or AGM battery, such as super thermal stability, high deep discharge capability, good recovery from deep discharge, even if the battery is left discharged for three days, it will recover to 100% of capacity. With the above-mentioned advantages, the gel battery has long service life, specially suitable for motive power applications, such as golf trailer, sruubber, folklift, etc. The deep discharge cycles increased 50% as compared with the AGM battery.

Battery Construction

Component	Positive plate	Negative plate	Container	Cover	Safety valve	Terminal	Separator	Electrolyte
Raw material	Lead dioxide	Lead	ABS	ABS	Rubber	Copper	PVC	Gelled acid

General Features

- Nanometer SiO₂ and H₂SO₄ gelled electrolyte technology for efficiency gas recombination of up to 99% and freedom from electrolyte maintenance or water adding.
- Not restricted for air transport-complies with IATA/ICAO Special Provision A67.
- UL-recognized component.
- Can be mounted in any orientation.
- Computer designed lead, calcium tin alloy grid for high power density.
- Long service life, float or cyclic applications.
- Maintenance-free operation.
- Low self discharge.
- Case and cover available in both standard and flame restardant ABS.

Dimensions and Weight

Length(mm / inch)..... 490 / 19.29
 Width(mm / inch)..... 350 / 13.78
 Height(mm / inch)..... 345 / 13.58
 Total Height(mm / inch)..... 382 / 15.04
 Approx. Weight(Kg / lbs)..... 120 / 264.7

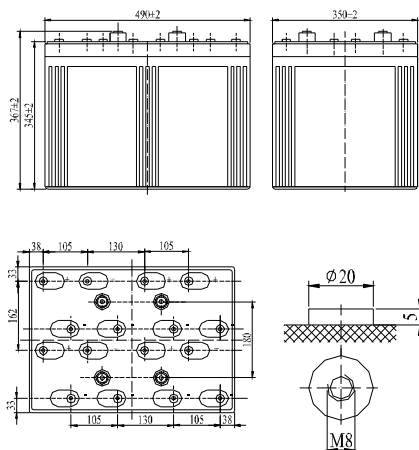

Total height with removable cover: 382

Performance Characteristics

Nominal Voltage	2V
Number of cell	1
Design Life	20 years
Nominal Capacity 77°F(25°C)	
10 hour rate (200A, 1.80V)	2000Ah
5 hour rate (352A, 1.75V)	1760Ah
1 hour rate (1240A, 1.60V)	1240Ah
Internal Resistance	
Fully Charged battery 77°F(25°C)	0.35mOhms
Self-Discharge	
2% of capacity declined per month at 20°C(average)	
Operating Temperature Range	
Discharge	-20~60°C
Charge	-10~60°C
Storage	-20~60°C
Max. Discharge Current 77°F(25°C)	4500A(5s)
Charge Methods: Constant Voltage Charge 77°F(25°C)	
Cycle use Charge Voltage:	2.40V-2.45V
Maximum charging current	400A
Temperature compensation	-5mV/°C
Standby use	2.25V-2.30V
No charge current limit is required	
Temperature compensation	-3.3mV/°C

Discharge Constant Current (Amperes at 77°F25°C)

End point volts/cell	10min	15min	30min	1h	3h	5h	10h	20h
1.60V	4200	3440	2000	1240	520	380	210	112
1.65V	3960	3200	1960	1200	507	368	208	110
1.70V	3720	3040	1920	1160	493	360	204	108
1.75V	3480	2800	1880	1120	487	352	202	107
1.80V	3240	2560	1800	1060	467	340	200	105

Discharge Constant Power (Watts at 77°F25°C)

End point volts/cell	10min	15min	30min	1h	3h	5h	10h	20h
1.60V	7190	5834	3744	2321	973	730	407	220
1.65V	6843	5786	3575	2208	924	689	369	208
1.70V	6666	5545	3410	2116	876	657	362	199
1.75V	6348	5197	3309	2043	833	642	349	192
1.80V	6013	4915	3168	1950	784	598	326	185

(Note)The above characteristics data are average values obtained within three charge/discharge cycles not the minimum values.

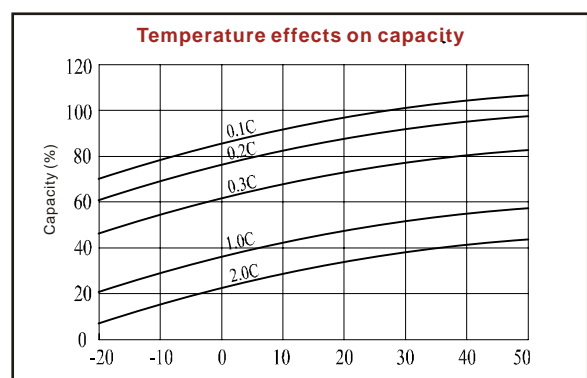
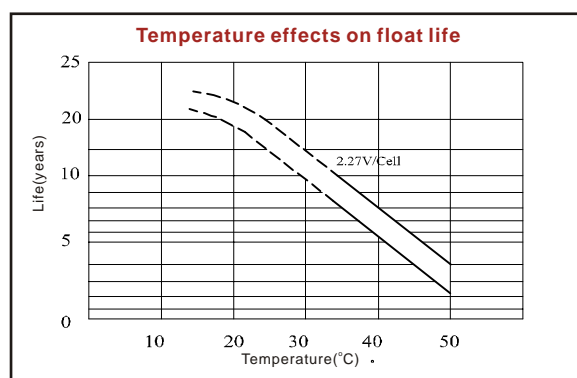
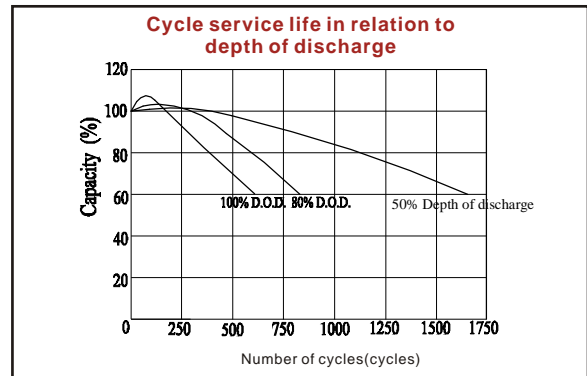
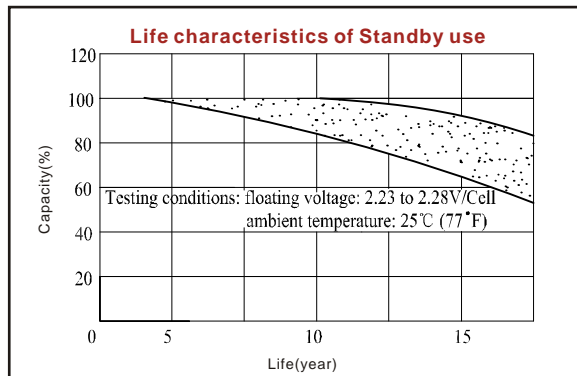
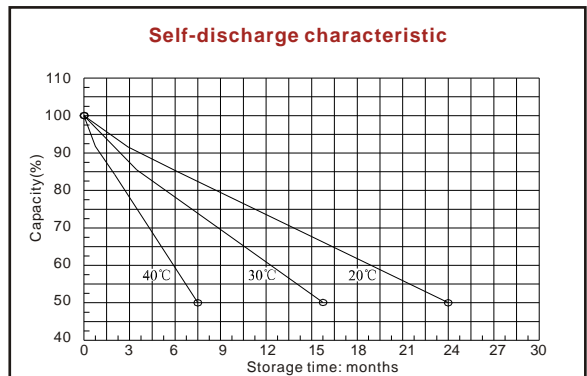
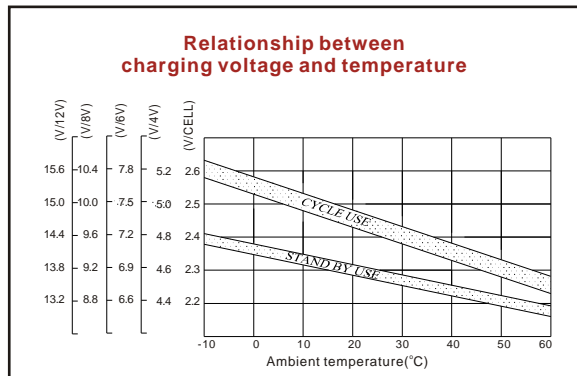
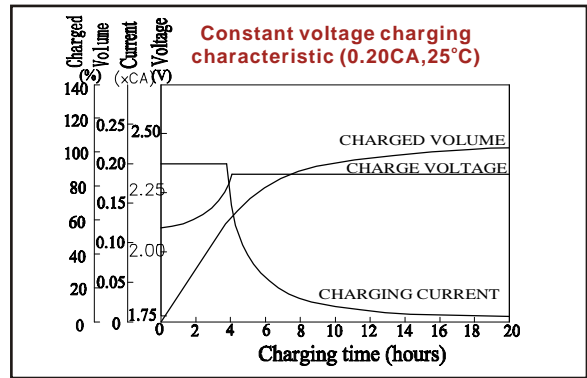
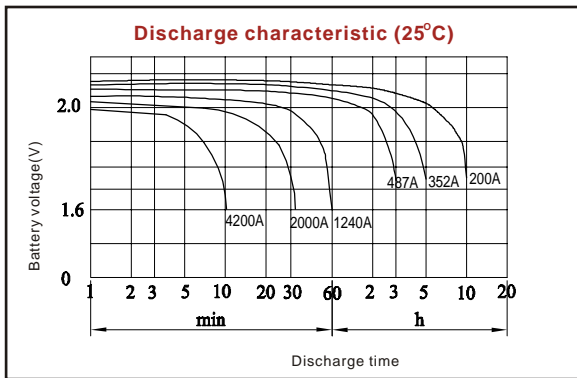

ISO9001:2000

MH25860

G4M19906-9202-E-16

www.vision-batt.com

Shenzhen Center Power Tech. Co., Ltd.
 Center Power Industrial Park, Tongfu Industrial District Dapeng Town, 518120 Shenzhen, China
 Tel: (+86-755) 8431 8088 Fax: (+86-755) 8431 8038 E-mail: sales@vision-batt.com